

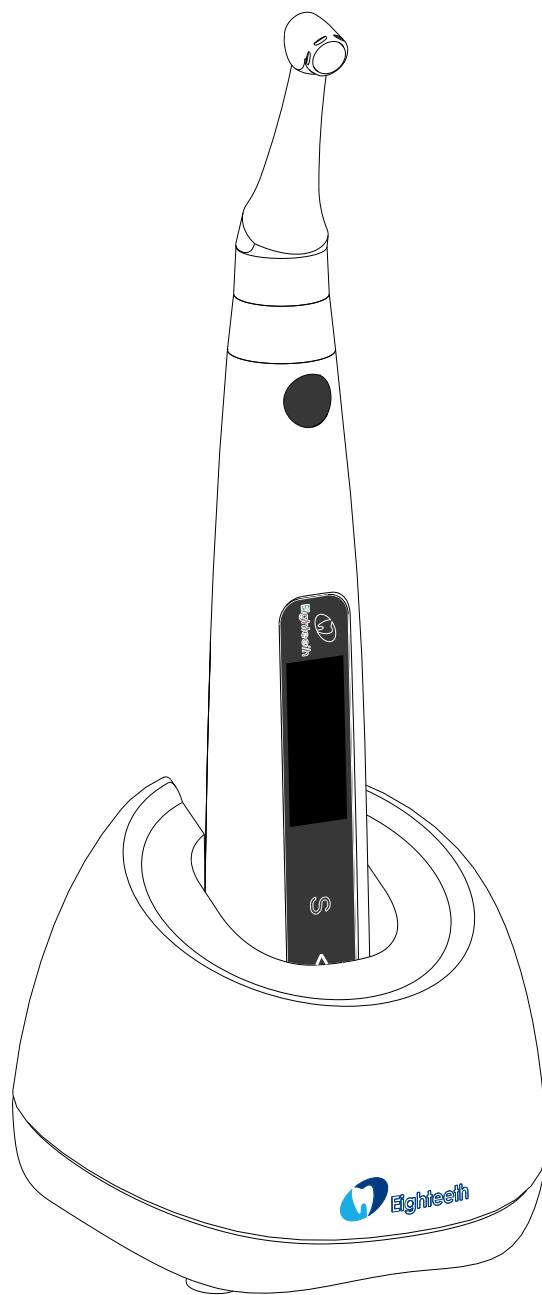

CE  
0197



***E-connect S***

# USER MANUAL

---

## Content

<b>1. Scope of E-connect S</b> .....	<b>5</b>
1.1 Parts Identification .....	5
1.2 Components and Accessories .....	6
1.3 Options (sold separately) .....	6
<b>2. Symbols used in the User Manual</b> .....	<b>8</b>
<b>3. Before Use</b> .....	<b>10</b>
3.1 Intended Use .....	10
3.2 Contraindications .....	10
<b>4. Installing the E-connect S</b> .....	<b>12</b>
4.1 Installation of the contra angle.....	13
4.2 Install the file .....	13
4.3 Connecting measuring wire .....	14
4.4 Connecting charge base .....	14
<b>5. Use Interface</b> .....	<b>17</b>
5.1 Panel key .....	18
5.2 Screen display .....	19
5.3 Terms and definition .....	23
<b>6. Setting</b> .....	<b>25</b>
6.1 Selecting memory.....	25
6.2 Setting parameters.....	25
6.3 Preset programs .....	28
6.4 Advanced setting.....	30
6.5 Parameter logic.....	32
<b>7. Operation</b> .....	<b>36</b>
7.1 Charge.....	36
7.2 Motor operation.....	37
7.3 Apex operation and not suitable condition.....	39

---

<b>8. Maintenance</b> .....	<b>45</b>
<b>9. Error Warning</b> .....	<b>48</b>
<b>10. Troubleshooting</b> .....	<b>49</b>
<b>11. Technical Data</b> .....	<b>52</b>
<b>12. EMC Tables</b> .....	<b>53</b>
<b>13. Statement</b> .....	<b>58</b>



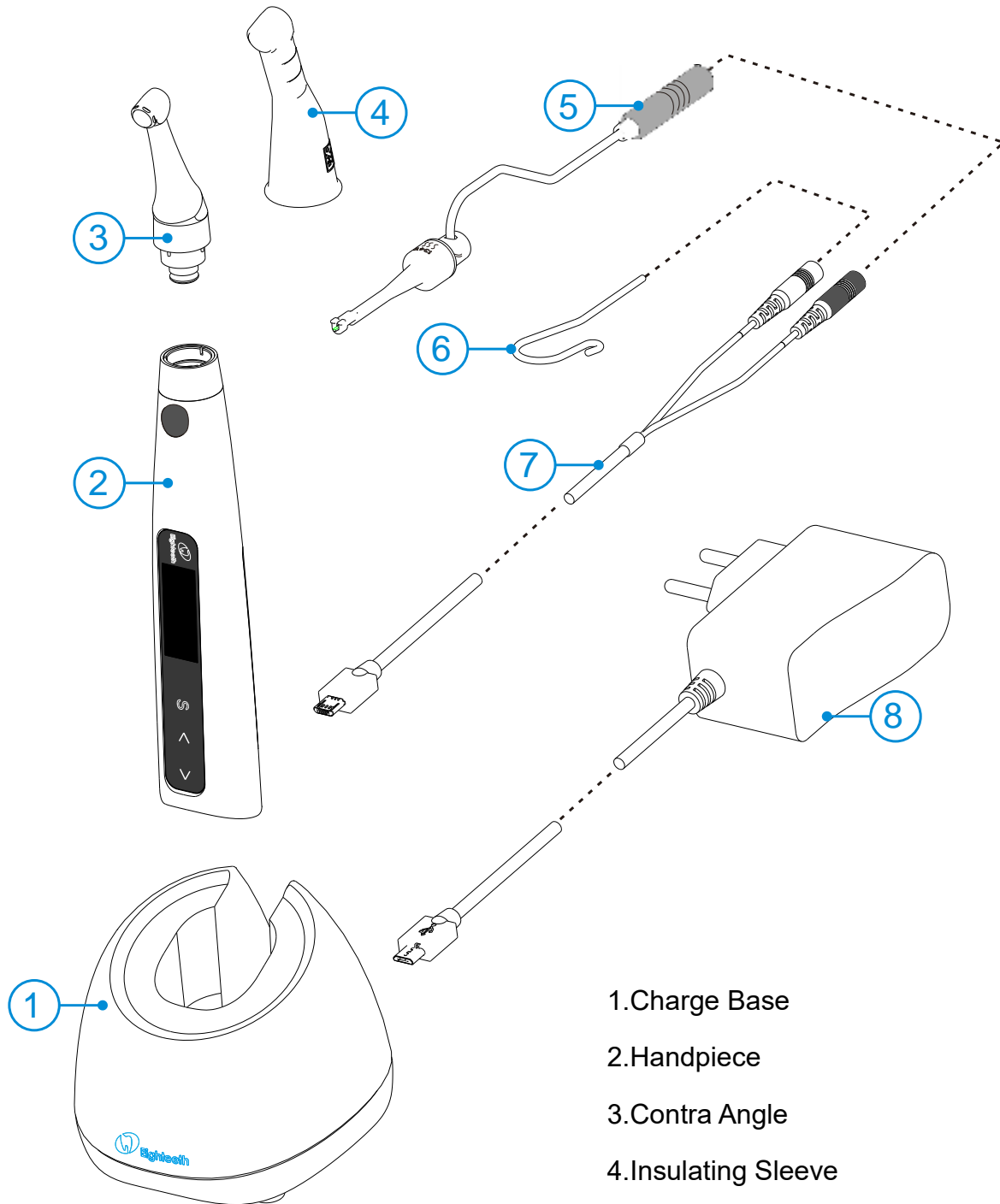

# 1. Scope of E-connect S

## 1.1 Parts Identification

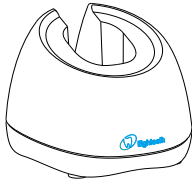
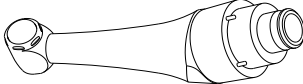
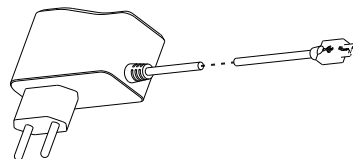
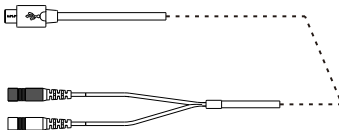
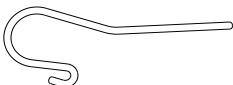

- 1.Charge Base
- 2.Handpiece
- 3.Contra Angle
- 4.Insulating Sleeve
- 5.File Clip (2 pcs)
- 6.Lin Hook (2 pcs)

## 1.2 Components and Accessories





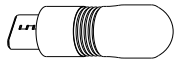

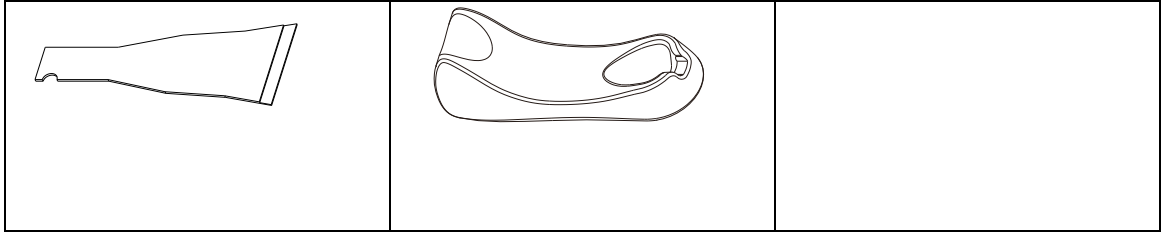







<p>Motor Handpiece (1pcs) Part No. 6051032</p> 	<p>Charge Base (1pcs) Part No. 6051033</p> 	<p>Contra Angle (1pcs) Part No. 6041003</p> 
<p>Adapter (1pcs) Part No. 6016001</p> 	<p>Measuring Wire (1pcs) Part No. 6015011</p> 	<p>Lip Hook (2pcs) Part No. 6072002</p> 
<p>File clip (2pcs) Part No. 6051005</p> 	<p>Insulating Sleeve (1pcs) Part No. 6004027</p> 	<p>Spray Nozzle (1pcs) Part No. 6051037</p> 

## 1.3 Options (sold separately)

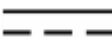
<p>Disposable Sleeve Part No. 6031009</p>	<p>Handpiece Base Part No. 6005002</p>	<p>Apex Tester (1pcs) Part No. 6016001</p> 
---	--	--



## 2. Symbols used in the User Manual

 <b>WARNING</b>	If the instructions are not followed properly, operation may lead to hazards for the product or the user/patient.
 <b>NOTE</b>	Additional information, explanation of operation and performance.
	Serial number
	Catalogue number
	Manufacturer
	Date of manufacture
	Safety class II device
	Type BF applied part
	CE marking
	Direct current
	Do not dispose of with normal household waste
	Store in a dry place
	Consult instructions for use
	Can be autoclaved up to a maximum temperature of 134° Celsius
	Authorized Representative in the European Community



---

	Manufacturer's LOGO
---	---------------------

## 3. Before Use

### 3.1 Intended Use

E-connect S is exclusively designed for dentists for use with dental root canal instruments in continuous rotation and in reciprocating movement with integrated apex locator.

This device must only be used in hospital environments, clinics or dental offices by qualified dental personnel.

### 3.2 Contraindications

The integrated apex locator of the E-connect S is contraindicated in cases where patient/user carry medical implants such as pace makers or cochlear implants etc.

Do not use the device for implants or other non-endodontic dental procedures.

Safety and effectiveness have not been established in pregnant women and children.



#### **WARNING**

Read the following warnings before use:

1. The device must not be placed in humid surroundings or anywhere where it can come into contact with any type of liquids.
2. Do not expose the device to direct or indirect heat sources. The device must be operated and stored in a safe environment.
3. The device requires special precautions with regard to electromagnetic compatibility (EMC) and must be installed and operated in strict compliance with the EMC information. In particular, do not use the device in the vicinity of fluorescent lamps, radio transmitters, remote controls, portable or mobile RF communication devices and do not charge, operate or store at high temperatures. Comply with the specified operating and storage conditions.
4. Gloves and a rubber dam are compulsory during treatment.
5. If irregularities occur in the device during treatment, switch it off. Contact the agency.
6. Never open or repair the device yourself, otherwise, void the warranty.



## 4. Installing the E-connect S

## 4.1 Installation of the contra angle

Make sure 4 pins on contra angle alignment the slots of handpiece, plug them together until it “click” securely into place.

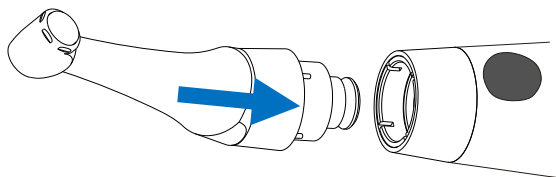

The contra angle can be 340 degrees rotated without take off, make it easy to watch the LCD in treatment by rotating the contra-angle.

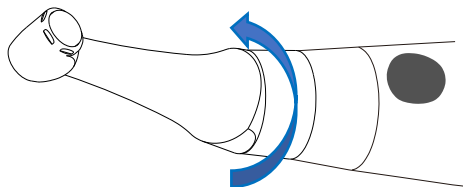

### **WARNING**

Make sure the assembly is connected properly, otherwise might cause unexpected motor reverse, even hurt the patients

After connecting the contra angle and handle, pull it gently to make sure the connection is good.

The improve insulation of the contra angle during combine apex, we

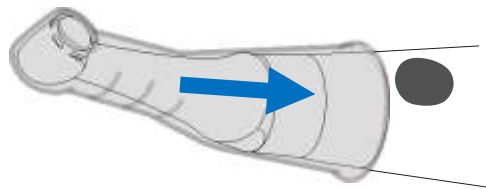

You can also use disposable sleeve (sold separately) instead of insulating sleeve



### **NOTE**

Without the insulating sleeve, when performing the apex measurement with handpiece, wear appropriate insulated gloves, and make sure the contra angle does not touch the lips. It is advisable to use a rubber dam when performing such treatments.

## 4.2 Install the file

Turn the file back and forth until it is lined up with interior latch groove and slips into place, lock the file into the contra angle.

Hold down the push button on the contra angle and can release the file.

recommend using an insulating sleeve.

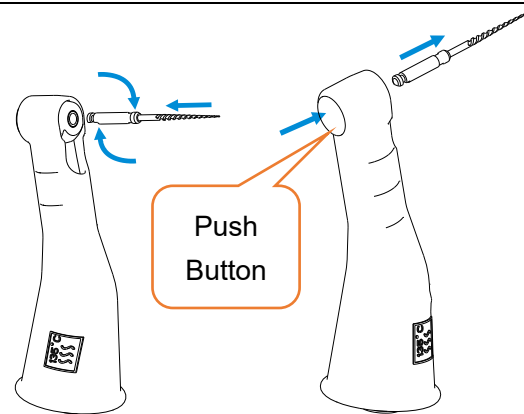

**! WARNING**

Inspect the file head before inserting the file. Do not use the damaged file head.

Make sure the motor is stopped when inserting and removing files.

Be careful when inserting and removing files to avoid injury to fingers.

Take care not to touch the Main switch when putting files in. this will cause the file to rotate.

Pull the file gently to make sure that the file is secure in handpiece properly, otherwise it may pop out and hurt the patient.

**4.3 Connecting measuring wire**

If want activity apex measurement function, uncap the USB cover on handpiece, insert measuring wire.

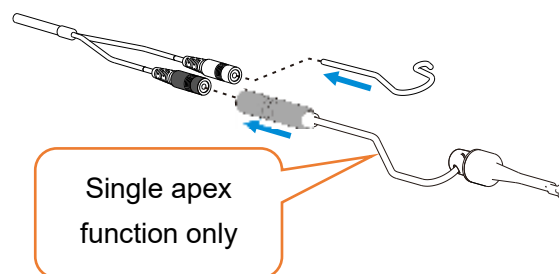

**! NOTE**

Match colors to connect the lip hook and file clip, if connect lip hook with black slot, apex auto start will have no function.

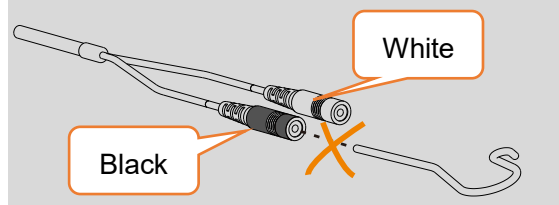

**4.4 Connecting charge base**

Plug the USB of adapter into the charge base, and plug the other end into a power outlet, the Power LED on charge base will light up (green).

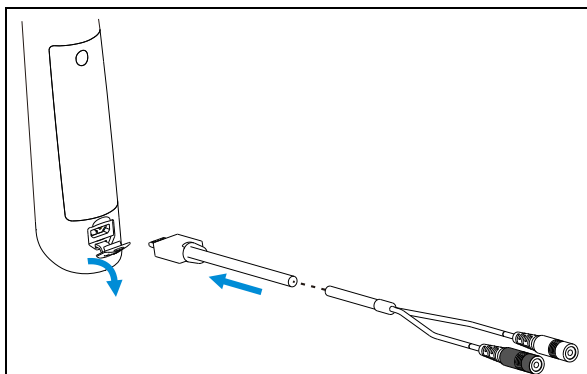

Insert lip hook into white slot, insert file clip into black slot.

**NOTE**

It's not necessary to connect file clip during motor combine apex function, only during single apex function.

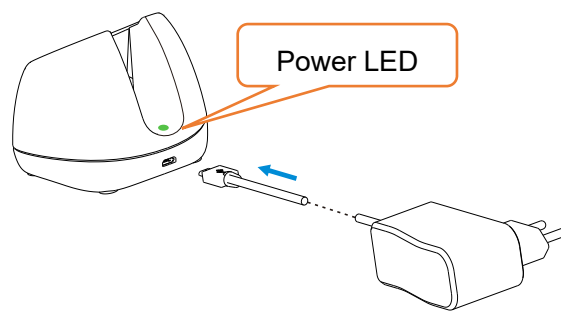

**NOTE**

Only the original adapter could be used.

Put the handpiece all the way into the charge base, the charge state will show on the screen.

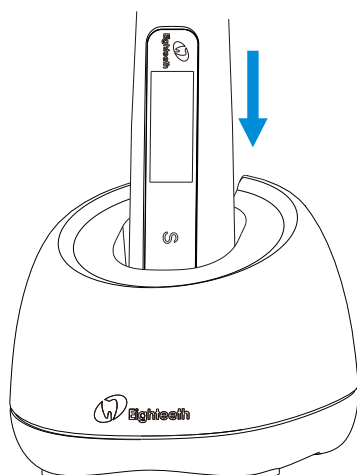

**NOTE**

Put the handpiece into the charge base

If only need a base to put the device on dentist element of dental chair ( without charge function ), handpiece base is recommended ( sold separately ) to instead of charge base.

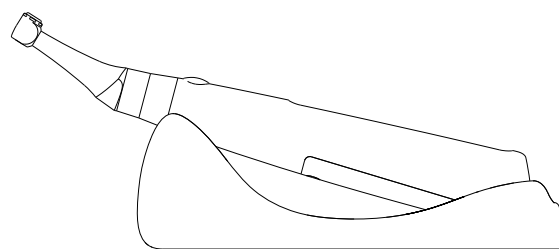

in the right direction, otherwise the handpiece will not be recharged.

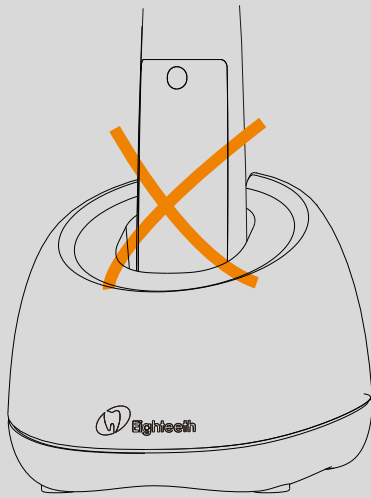



## 5.Use Interface

## 5.1 Panel key

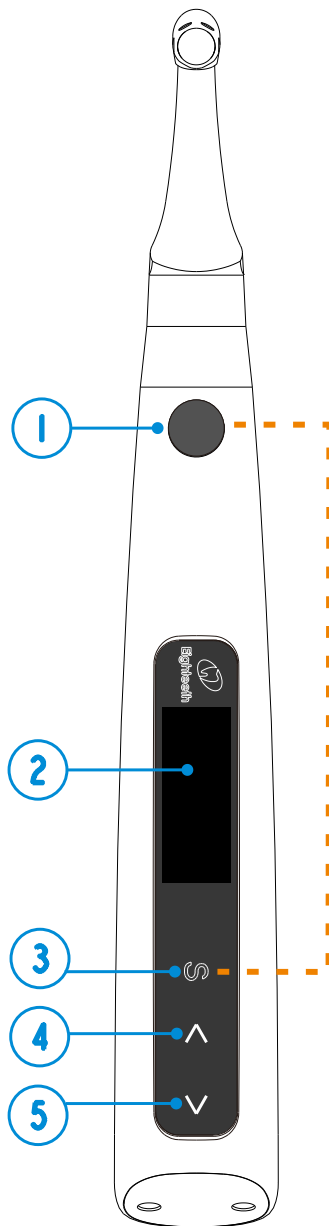

- ① ● Main switch
- ② Display Screen
- ③ S Setting key
- ④ < Decrease key

### Turn Power On

Press ● more than 0.5 seconds to turn on the instrument

### Memory Change

Press < or > during standby state

### Operation mode Change

Press S once during standby state, press < or > to change, then press ● or wait 5 seconds to confirm

### Parameter Adjustment



Press S till target parameters, press < or > to adjust, then press ● or wait 5 seconds to confirm

### Preset Program Selection

Long press S to entry preset program during standby state, press < or > to change, then press ● to confirm

### Turn Power Off

Holding down press S then press ●

<p>⑤  Increase key</p>	<p><b>Advanced setting</b></p> <p>During power off state, holding down press <b>S</b> then press  to entry advanced setting, Press <b>S</b> till target setting, press <b>&lt;</b> or <b>&gt;</b> to adjust, then press  to confirm</p>
---	---

## 5.2 Screen display

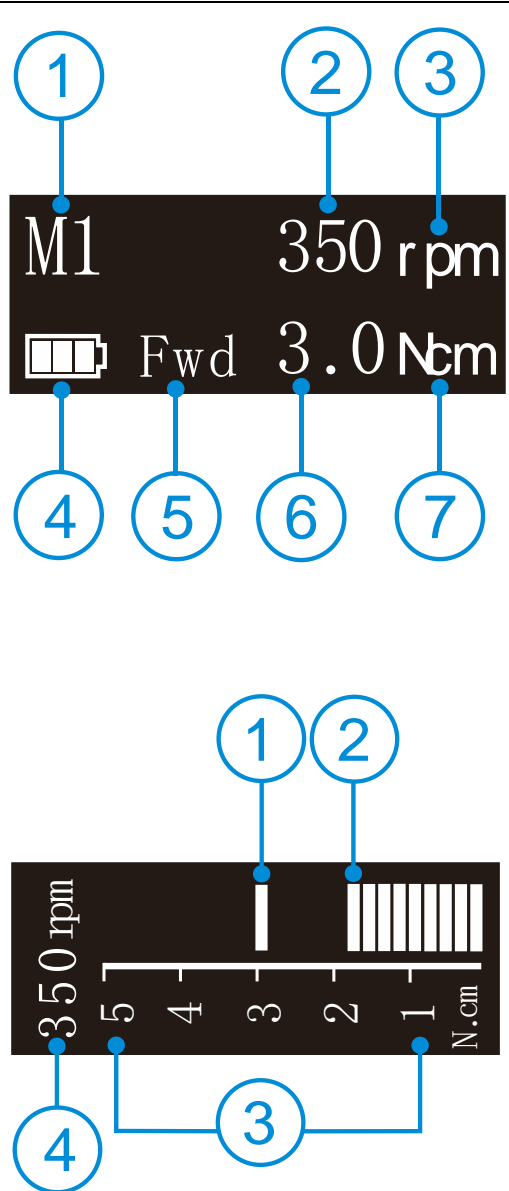
	<p><b>Standby interface</b></p> <ul style="list-style-type: none"> <li>① Memory mode number</li> <li>② Speed of this memory program</li> <li>③ Unit of speed: Revolutions Per minute</li> <li>④ Residual battery power</li> <li>⑤ Operation mode</li> <li>⑥ Torque of this memory program</li> <li>⑦ Unit of torque: Newton centimeter</li> </ul> <p><b>Standard working mode</b></p>
--	---

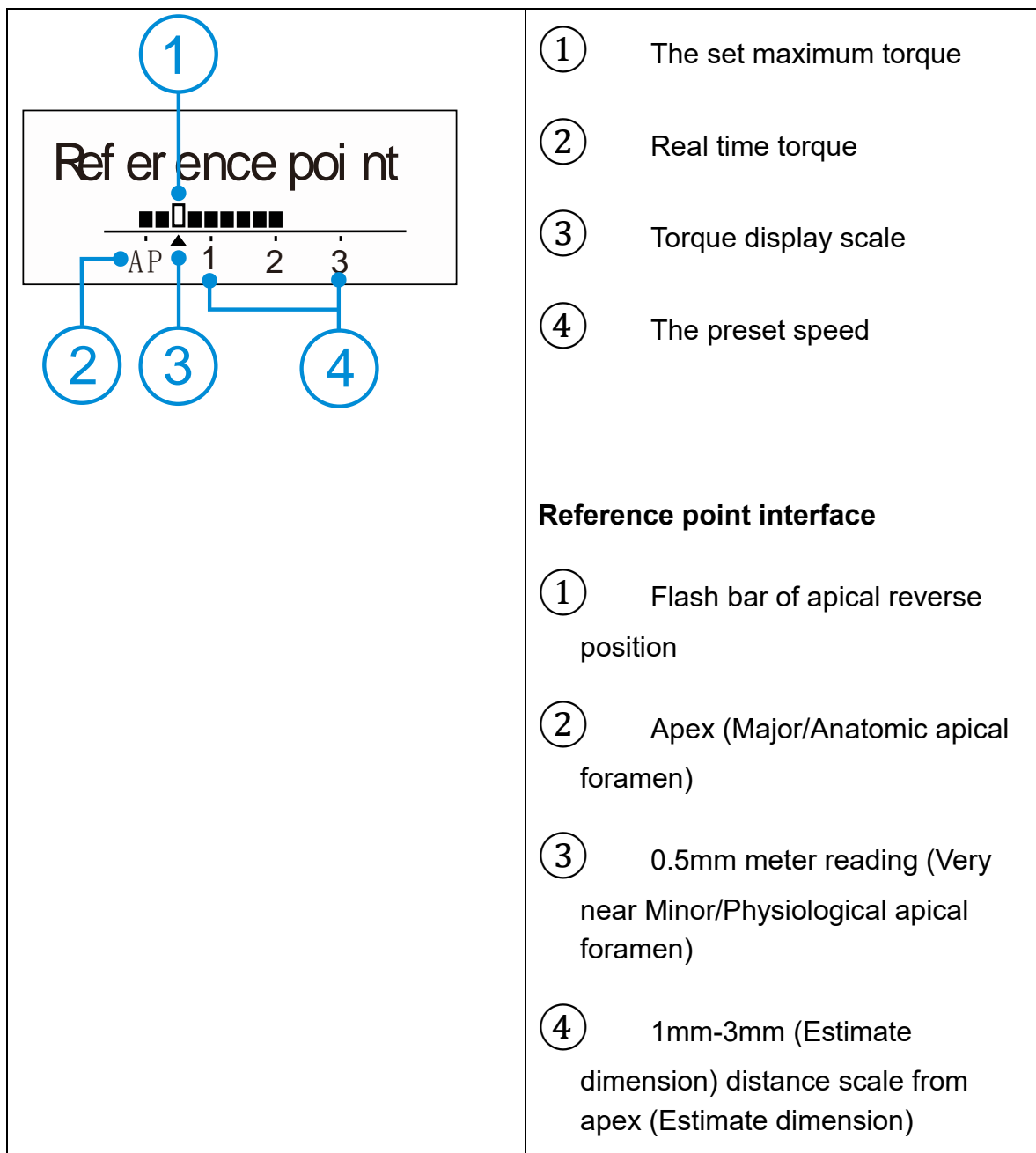

- ① The set maximum torque
- ② Real time torque
- ③ Torque display scale
- ④ The preset speed

**Reference point interface**

- ① Flash bar of apical reverse position
- ② Apex (Major/Anatomic apical foramen)
- ③ 0.5mm meter reading (Very near Minor/Physiological apical foramen)
- ④ 1mm-3mm (Estimate dimension) distance scale from apex (Estimate dimension)

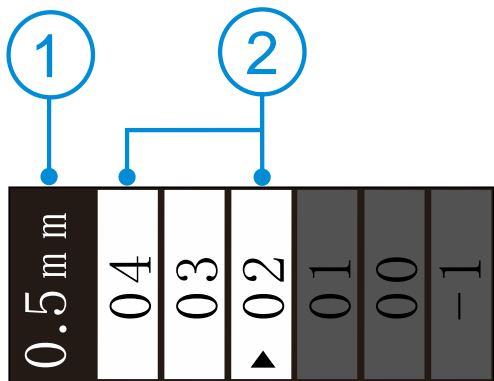
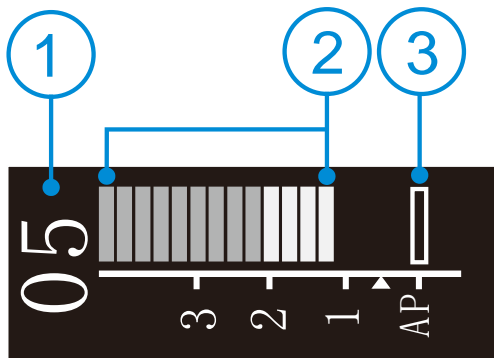
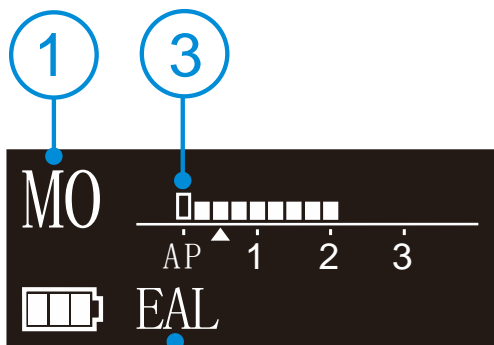

### Canal measurement standby interface

- ① Memory mode number  
M0 is apex stand-alone memory
- ② Electronic apex locator
- ③ Apex flash bar

### Canal measurement start interface

- ① Indication number  
The number has no represent of actual length, only for indication
- ② Canal length indicator bar
- ③ Apex flash bar (apex stand-alone mode) or reference point flash bar (motor combine with apex mode)

### Canal measurement approach apex interface

- ① The estimate dimension from apex (Major/Anatomic apical foramen)
- ② Canal length indicator bar

---

--	--

## 5.3 Terms and definition

Fwd	Forward ( Clockwise rotation )
Rev	Reverse ( Counter clockwise rotation ) Be applied to special file, inject calcium hydroxide and other solutions
REC	Reciprocation Be applied to reciprocating file, path file and rotary file protection by setting some special angle
ATC	Adaptive torque control Up to setting torque, the motor will move with reciprocating mode; when torque reduce to normal value, the motor will clockwise rotate
EAL	Electronic apex locator In the mode, the device will work like a stand-alone apex locator
AP	Apex Major apical foramen or Anatomic apical foramen
R.L	Torque reverse less The motor will not reverse rotation no matter how large the torque load is
Reference point	During combined length determination, normally apical reverse must active before reaching major apical foramen, setting apical reverse position by change the flash bar
FWD Angle	Forward angle (Clockwise rotation angle), activating in REC and ATC operation mode
REV Angle	Reverse angle (Counter Clockwise rotation angle), activating in REC and ATC operation mode
Memory Mode	Such as M0-M10

---

Operation Mode	Such as FWD, REV, REC and ATC
----------------	-------------------------------



## 6.Setting

### 6.1 Selecting memory

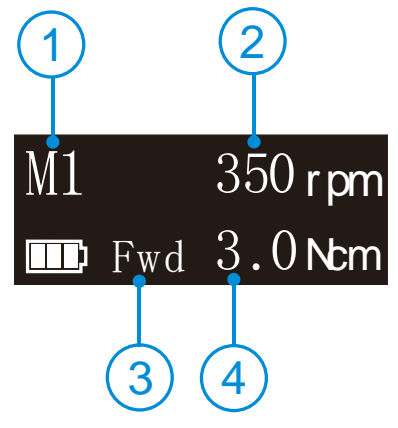
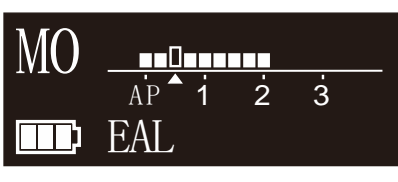
	<p>E-connect S has 11 memory programs, press <b>&lt;</b> or <b>&gt;</b> to change during standby state, the memory number (○,1) will change according.</p> <p>M1-M10 is standard working memory for canal shaping, every memory has its own speed (○,2), mode (○,3) and torque (○,4), all this these parameters can be changed (<b>See chapter 6.2 Setting parameters</b>).</p>
	<p>M0 is special memory for stand-alone apex locator function (<b>See chapter 7.3 Apex operation and not suitable condition</b>).</p>





### 6.2 Setting parameters



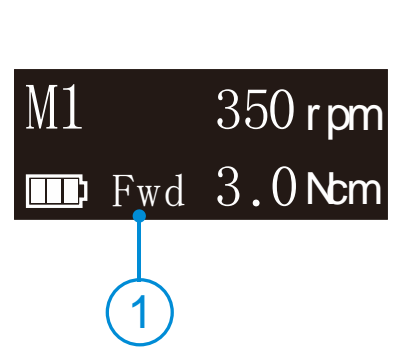









#### WARNING

All the parameters must be set according to files, make sure all the parameters are expected before starting the motor, otherwise has risk of file broken.

	<p>Before start the motor, check the operation mode (○,1) is correct, otherwise press <b>S</b> once during standby state, press <b>&lt;</b> or <b>&gt;</b> to change.</p>
---	---

<div style="border: 1px solid black; padding: 10px; text-align: center;"> <p>Operation Mode</p> <p><b>Fwd</b></p> </div>	<p>E-connect S has 4 operation modes: FWD, REV, REC and ATC (<b>See chapter 5.3 Terms and definition to get the explanations of these modes</b>).</p> <div style="background-color: #f0f0f0; padding: 5px;">  <b>NOTE</b>        When choice REV mode, a slow beep alarm sound appears after starting the motor, used for indicating counter clockwise rotation happening.     </div>
<p>Repeatedly press <b>S</b> to check all the next level parameters of this operation mode are expected, press <b>&lt;</b> or <b>&gt;</b> to change if not.</p> <div style="background-color: #f0f0f0; padding: 5px;">  <b>NOTE</b>        The parameter will differ in difference mode according to certain logic (<b>See chapter 6.5 Parameter logic</b>).     </div>	
<div style="border: 1px solid black; padding: 10px; text-align: center;"> <p>Speed</p> <p><b>300 rpm</b></p> </div>	<p>The speed setting can be adjusted from 120 rpm to 1000 rpm.</p> <div style="background-color: #f0f0f0; padding: 5px;">  <b>NOTE</b>        The speed of REC and ATC operation mode is difference according to certain logic (<b>See chapter 6.5 Parameter logic</b>).     </div>
<div style="border: 1px solid black; padding: 10px; text-align: center;"> <p>Torque Limit</p> <p><b>3.0 Ncm</b></p> </div>	<p>The torque setting can be adjusted from 0.5 N·cm to 4.0 N·cm, and R.L (torque reverse less) is also available.</p> <div style="background-color: #f0f0f0; padding: 5px;">  <b>NOTE</b>        The torque of REC and ATC operation mode is difference according to certain logic (<b>See chapter 6.5 Parameter logic</b>).     </div> <div style="background-color: #f0f0f0; padding: 5px; margin-top: 10px;">  <b>WARNING</b>        When choice R.L (torque reverse less), a slow beep alarm sound appears after starting the motor.     </div>

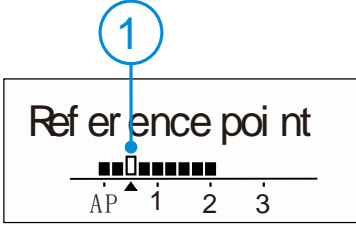

	<p>Be careful to use this function, very professional skill is needed, otherwise has risk of file broken.</p>
<div data-bbox="284 698 579 813" style="border: 1px solid black; padding: 5px; text-align: center;">       Auto Start <b>ON</b> </div>	<p>E-connect S integrated apex locator, if the lip hook is connecting with patient's lip, when the endo file entering root canal, the motor will start automatically.</p> <p>Press  or  to shut off this function if not expected, press  to start and stop the motor.</p> <div data-bbox="663 752 1386 1077" style="border: 1px solid gray; padding: 10px;">  <b>WARNING</b>        The motor will start automatically if handpiece (without insulating sleeve) or file touch the patient's lip or operator's fingers (without insulating glove), take care to avoid this, the file rotated by motor has risk of injure someone.     </div>
<div data-bbox="284 1122 579 1236" style="border: 1px solid black; padding: 5px; text-align: center;">       Auto Stop <b>OFF</b> </div>	<p>When the endo file out of root canal, the motor will not auto stop with default setting, Press  or  to select auto stop "ON" if needed.</p>
<div data-bbox="284 1585 579 1700" style="border: 1px solid black; padding: 5px; text-align: center;">       Apical Action <b>Reverse</b> </div>	<p>Because of integrated apex locator, when the file reaches the reference point, the motor will response according to setting, it can be Reverse, SlowDown, Stop and Off.</p> <p>Press  or  to change.</p> <p><b>Reverse:</b> rotation direction changing till the file upward a little bit by operator, rotation direction will change back again.</p> <p><b>SlowDown:</b> rotation slowdown when approach the reference point, will reverse if reach.</p> <p><b>Stop:</b> rotation stop when reach the reference point, upward a little bit and will rotate again.</p> <p><b>Off:</b> rotating as usual even if reach the reference point.</p>

	<p>During combined length determination, normally apical reverse must active before reaching major apical foramen, Press <b>&lt;</b> or <b>&gt;</b> to set apical reverse position by change the flash bar (○,1), the motor will reverse while reaching the flash bar every time.</p>
<div style="border: 1px solid black; padding: 5px; text-align: center;">       FWD Angle  <b>120°</b> </div>	<p>Activating in REC and ATC operation mode. forward angle (Clockwise rotation angle) can be adjusted by operator from 30° to 370°, Press <b>&lt;</b> or <b>&gt;</b> to change.</p>
<div style="border: 1px solid black; padding: 5px; text-align: center;">       REV Angle  <b>150°</b> </div>	<p>Activating in REC and ATC operation mode. reverse angle (Counter Clockwise rotation angle) can be adjusted by operator from 30° to 370°, Press <b>&lt;</b> or <b>&gt;</b> to change.</p>
	<p> <b>NOTE</b></p> <p>The sum of FWD Angle and REV Angle must be greater than 120°, the motor system has closed the angle not needed. For example: if you set FWD Angle 30°, the REV Angle must be setting greater than 90°.</p>

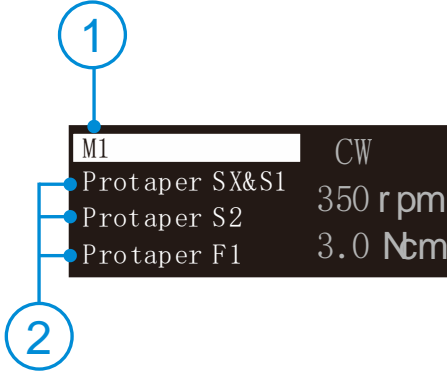

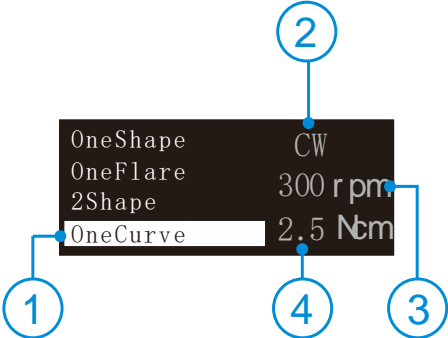
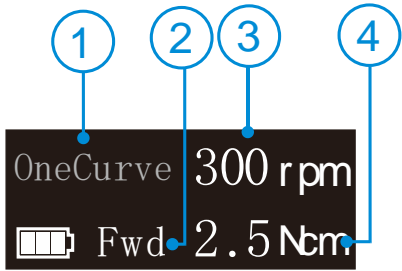
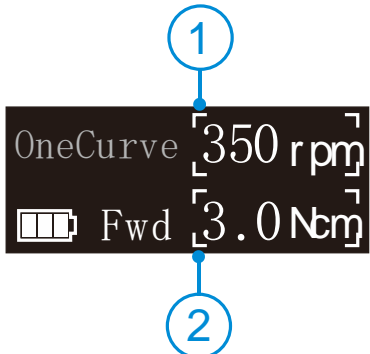
### 6.3 Preset programs

	<p>For convenience, we preset some common file system.</p> <p>Long press <b>S</b> to entry preset program during standby state, the interface will show as left.</p> <p>M1 (○,1) meanings the current memory mode, you can replace it by preset program (○,2) press <b>&lt;</b> or <b>&gt;</b> to change, then press <b>●</b> to confirm.</p>
---	---

	<p>If you selecting “OneCurve” (○,1), the operation mode (○,2), speed (○,3) and torque limit (○,4) will change according to the file system default setting.</p> <p><b>NOTE</b></p> <p>Protaper<sup>○,R</sup>, GATES<sup>○,R</sup>, Pro.Glider<sup>○,R</sup>, and Wave one<sup>○,R</sup> is a registered trademark of Dentsply.</p> <p>Mtwo<sup>○,R</sup>, Flex.Master<sup>○,R</sup>, Reciproc<sup>○,R</sup> and R-Pilot<sup>○,R</sup> is a registered trademark of VDW.</p> <p>K3XF<sup>○,R</sup>, TF<sup>○,R</sup> is a registered trademark of SybronEndo.</p> <p>OneG<sup>○,R</sup>, OneShape<sup>○,R</sup>, OneFlare<sup>○,R</sup>, 2Shape<sup>○,R</sup> and OneCurve<sup>○,R</sup> is a registered trademark of Micro-Mega</p> <p>XPendo.Shaper<sup>○,R</sup>, XPendo.Finisher<sup>○,R</sup>, iRace<sup>○,R</sup>, BT-Race<sup>○,R</sup> and BioRace<sup>○,R</sup> is a registered trademark of FKG</p>
	<p>And the memory mode (○,1) will change according, also operation mode (○,2), speed (○,3) and torque limit (○,4) will charge according to the file system default setting.</p> <p><b>NOTE</b></p> <p>All of memory mode (from M1-M10) can be replaced with same mothed.</p>
	<p>The parameters of “OneCurve” can also be changed make it different from default setting, and there will be 4 corners around the parameter (○,1)(○,2).</p> <p>If want to change back to default setting, long press <b>S</b> to entry preset program during standby state, select “OneCurve” and press</p>

	<p>  to confirm, the default setting will be recalled, and the 4 corners around will disappear.         </p> <p>           If want to change back to M1 (or M2-M10), long press <b>S</b> to entry preset program during standby state, press <b>&lt;</b> or <b>&gt;</b> to select M1 (or M2-M10) again, then press  to confirm         </p> <div style="background-color: #f0f0f0; padding: 5px;"> <p>  <b>WARNING</b> </p> <p>           Changing the default setting is not recommended only if you are very sure it can be changed, otherwise has risk of file broken.         </p> </div>
--	--

## 6.4 Advanced setting

<div style="border: 1px solid black; padding: 5px; text-align: center;"> <p>Ver si ons E.1.1.008</p> </div>	<p>           During power off state, holding down press <b>S</b> then press  to entry advanced setting, the version number software will appear on the display screen.         </p> <p>           E-connect S can update software very easy without tools and software. Contact your distributor to update if necessary.         </p> <div style="background-color: #f0f0f0; padding: 5px;"> <p>  <b>NOTE</b> </p> <p>           After updating, all of the setting parameters will be covered.         </p> </div>
<div style="border: 1px solid black; padding: 5px; text-align: center;"> <p>Aut o Power Of f 10 M n</p> </div>	<p>           Press <b>S</b> again, the “Auto Power Off” time can be change, press <b>&lt;</b> or <b>&gt;</b> to adjust, then press  to confirm.         </p> <p>           The “Auto Power Off” time can be set from 3-15 minutes.         </p>

<div style="border: 1px solid black; padding: 5px; text-align: center;"> <p>Auto Return time 5 Sec</p> </div>	<p>Press <b>S</b> again, the “Auto Return time” can be change, it means when setting parameters just like speed and torque, the system will back to standby interface if there is no operation in 5 seconds.</p> <p>press <b>&lt;</b> or <b>&gt;</b> to adjust, then press <b>●</b> to confirm.</p> <p>The “Auto Return time” can be set from 3-15 seconds.</p>
<div style="border: 1px solid black; padding: 5px; text-align: center;"> <p>Beeper Volume Vol . 2</p> </div>	<p>Press <b>S</b> again, the “Beeper Volume” can be change, press <b>&lt;</b> or <b>&gt;</b> to adjust, then press <b>●</b> to confirm.</p> <p>The “Beeper Volume” can be set from 0-3.</p>
<div style="border: 1px solid black; padding: 5px; text-align: center;"> <p>Habit hand Right Hand</p> </div>	<p>Press <b>S</b> again, the “Habit hand” can be change, press <b>&lt;</b> or <b>&gt;</b> to adjust, then press <b>●</b> to confirm.</p> <p>The right hand and the left hand can be set.</p>
<div style="border: 1px solid black; padding: 5px; text-align: center;"> <p>Start up memory M1</p> </div>	<p>Press <b>S</b> again, the “Start memory” can be change, it means every time turn power on, which memory mode will appear first.</p> <p>press <b>&lt;</b> or <b>&gt;</b> to adjust, then press <b>●</b> to confirm.</p> <p>M1 and Last (the memory mode number when you turn power of ) can be set.</p>
<div style="border: 1px solid black; padding: 5px; text-align: center;"> <p>Calibration OFF</p> </div>	<p>Press <b>S</b> again, entry “Calibration” function, press <b>&lt;</b> or <b>&gt;</b> to select “ON”, press <b>●</b> to start calibration.</p> <div style="background-color: #f0f0f0; padding: 10px; border: 1px solid #ccc;"> <p> <b>WARNING</b></p> <p>Before calibrating, making sure the original contra angle is installed, and do not install the file.</p> <p>The torque will not correct if calibration without original contra angle or any load on contra angle chuck, and has risk of file broken.</p> </div>

<div style="border: 1px solid black; padding: 5px; width: fit-content; margin: auto;"> <b>Calibration</b> 1000 rpm         </div>	<p>The motor speed will increase from 120 to 1000 rpm.</p> <p>When the speed up to 1000 rpm, the calibration successful and automatic power off.</p>
<div style="border: 1px solid black; padding: 5px; width: fit-content; margin: auto;">           Restore settings OFF         </div>	<p>Press <b>S</b> again, entry “Restore setting” function, press <b>&lt;</b> or <b>&gt;</b> to select “ON”, press <b>●</b> to start recovering, all the parameters be set by operator will be recovered by default factory setting (<b>See chapter 6.5 Parameter logic</b>).</p> <div style="background-color: #f0f0f0; padding: 5px; margin-top: 10px;"> <p> <b>NOTE</b></p> <p>After restore setting, all the parameters will be covered, record what you need before this operation.</p> </div>

## 6.5 Parameter logic

The default **memory settings** are listed below, the setting can be changed as needed.

Function	M1	M2	M3	M4	M5	M6	M7	M8	M9	M10
<b>Operation Mode</b>	FWD	FWD	REC	REC	ATC	ATC	REV	REV	FWD	FWD
<b>Speed (rpm)</b>	300	400	350	450	450	300	350	500	800	1000
<b>Torque Limit (N·cm)</b>	3.0	2.0	N/A	N/A	1.5	1.5	2.5	2.0	1.5	1.0
<b>Auto Start</b>	ON	ON	ON	ON	ON	ON	ON	ON	ON	ON
<b>Auto Stop</b>	OFF	OFF	OFF	OFF	OFF	OFF	OFF	OFF	OFF	OFF



<b>Apical Action</b>	REV	REV	REV	REV	REV	REV	REV	REV	REV	REV
<b>Reference point</b>	02	02	02	02	02	02	02	02	02	02
<b>FWD Angle</b>	N/A	N/A	30	40	370	210	N/A	N/A	N/A	N/A
<b>REV Angle</b>	N/A	N/A	150	160	50	50	N/A	N/A	N/A	N/A

The default **advanced settings** are listed below, the setting can be changed as needed.

<b>Auto Power off</b>	10Min
<b>Auto Return time</b>	5Sec
<b>Beeper Volume</b>	2
<b>Habit hand</b>	Right hand

<b>Startup memory</b>	M1
<b>Language</b>	English
<b>Calibration</b>	OFF
<b>Restore settings</b>	OFF

The **speeds** (rpm) in different operation mode are not the same, details are listed below.

Fwd	Rev	REC	ATC
120 150 200 250 280 300 350 400 450 500 550 600 650 700 750 800 850 900 950 1000		150 200 250 300 350 400 450 500	

The **torques** (N·cm) in different operation mode are not the same, and even in the same operation mode, when the speed changing, the possible torque is difference, details are listed below.

Speed (rpm)	Fwd	Rev	REC	ATC
120-700	0.5 0.8 1.0 1.5 1.8 2.0 2.2 2.5 3.0 3.2 3.5 4.0 R.L		N/A	0.5 0.8 1.0 1.5 1.8 2.0 2.2 2.5 3.0
700-1000	0.5 0.8 1.0 1.5 1.8 2.0		N/A	N/A

The **FWD Angle** (degrees) and **REV Angle** (degrees) in different operation mode are not the same, details are listed below.

	Fwd	Rev	REC	ATC																								
FWD Angle	N/A		<table border="1"> <tr> <td>30</td><td>40</td><td>50</td><td>60</td><td>70</td><td>80</td> </tr> <tr> <td>90</td><td>100</td><td>120</td><td>150</td><td>160</td><td>180</td> </tr> <tr> <td>200</td><td>230</td><td>250</td><td>260</td><td>280</td><td>300</td> </tr> <tr> <td>320</td><td>340</td><td>360</td><td>370</td><td></td><td></td> </tr> </table>	30	40	50	60	70	80	90	100	120	150	160	180	200	230	250	260	280	300	320	340	360	370			The same with the front table
30	40	50	60	70	80																							
90	100	120	150	160	180																							
200	230	250	260	280	300																							
320	340	360	370																									
REV Angle	N/A		The same with the front table	The same with the front table																								







**NOTE**

The sum of FWD Angle and REV Angle must be greater than 120°, the motor system has closed the angle not needed. For example: if you set FWD Angle 30°, the REV Angle must be setting greater than 90°.

## 7.Operation

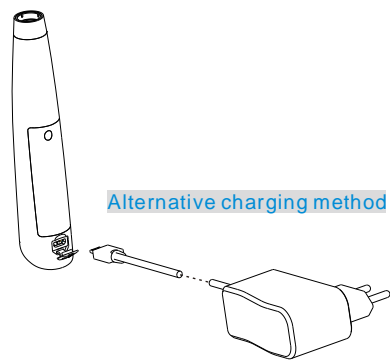
### 7.1 Charge

	<p>Displays the present remaining amount of the battery.</p> <p>Less than 15% remains, please charge.</p>
	<p> <b>NOTE</b></p> <p>If the power is less than 15%, must be recharged within 30 days, otherwise the battery will be damaged.</p>
<div style="border: 1px solid black; padding: 5px; text-align: center;"> <p><b>LowPower</b> Please Charge</p> </div>	<p>If continue to use, the torque and speed will low than the setting value, and low power warning will appear on screen, and the device will stop work.</p>
	<p> <b>NOTE</b></p> <p>The remaining amount of battery mark indicates a voltage. When a load is applied to the motor handpiece, the remaining amount of battery mark appears to become lower.</p>
 <p style="color: #00AEEF; font-size: small;">Alternative charging method</p>	<p>Charge without charge base also available, using adapter connect to handpiece directly, the charge state will show on the screen.</p> <p>Charge with charge base is recommended (<b>See chapter 4.4 Connecting charge base</b>).</p> <p> <b>NOTE</b></p> <p>Only the original adapter could be used.</p>

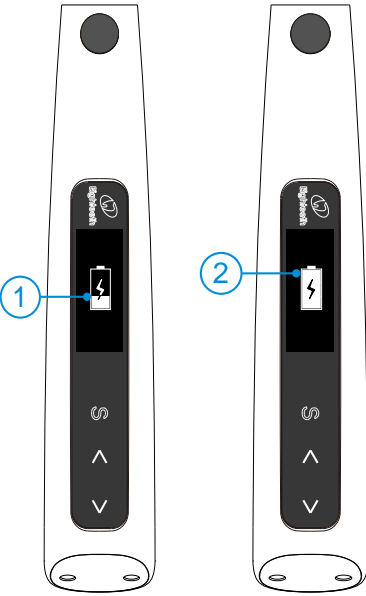
	<p>Charging indication appears on the screen, and flashes slowly (○,1), when battery is fully charged or in a state near full charge, the flash will stop and show like picture (○,2).</p> <p>Fully charged will take about 4 hours, depending on residual battery power and battery state.</p> <p>It can be recharged 300-500 times, depending on the operating conditions of the device.</p> <p><b>NOTE</b></p> <p>When changing, other function will forcibly stop, take from charge base, press main switch, the last function will recall.</p>
	<p><b>WARNING</b></p> <p>Do not change the battery, only trained technician or distributor can change the battery, the electronic parts will be damaged if use a wrong battery or install with a wrong way.</p>

## 7.2 Motor operation

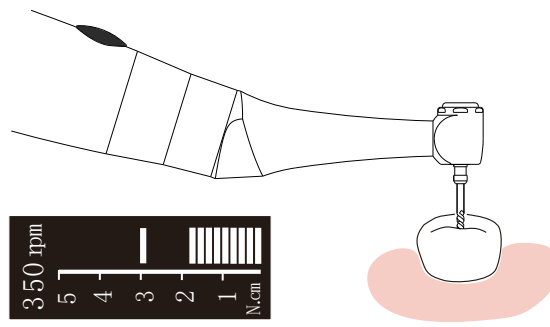
	<p>When using as a stand-alone motor, the torque bar will show on the screen (more information about torque bar, please see chapter 5.2 Screen display).</p>
<p><b>WARNING</b></p> <p>Use the E-connect S outside the oral cavity to make sure that the device is functioning properly.</p> <p>Change file on time to avoid file separation within the canal. File may separate</p>	

because of cyclic / torsional fatigue.

Heavy force / hand pressure on endo motor while using may even cause file separation.

Do not press the button to release the files while the motor is running, otherwise the file may pop out and even hurt the patient.

Electromagnetic noise in surroundings environment may interfere with the device operation, do not rely on device's automatic control completely, always pay attention to the feedback from display.



**NOTE**

If there is any abnormal functioning, stop using the device and report to company.

The file separates more easily at high speeds, please follow the manufacturer's recommendations of the speed and check the settings of the Endo motor before use.

Do not use the files are except nickel-titanium or stainless steel.

Gloves and a rubber dam are compulsory during treatment.

Do not forget to remove the file from the Contra-angle after its use.

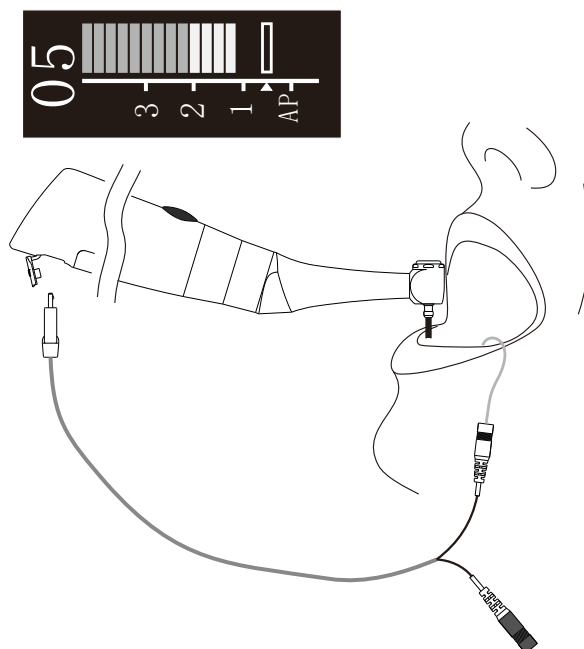

When using motor combine apex function, the measure wire must be connecting with motor by USB socket, and white slot connects with lip by lip hook, keep the black slot idle.

The reference point bar will show on the screen (**more information about reference point bar, please see chapter 5.2 Screen display**).

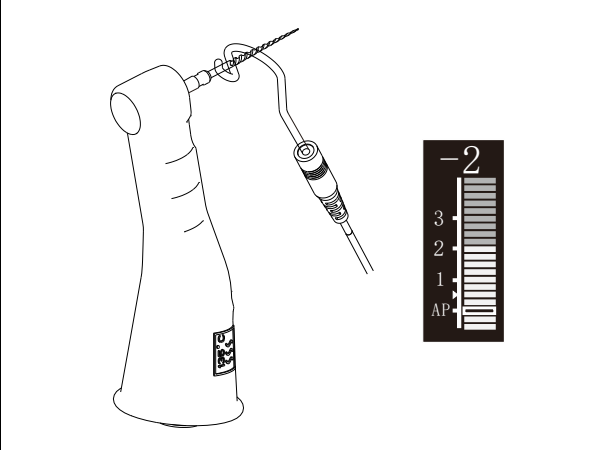

**NOTE**

We strongly recommend check the function every time before use.

Touch the lip hook with the file in the contra angle and check that all the bars on the meter on the screen light up, and the motor should be reversed continuously.

**NOTE**

The will not be able to perform a precise measurement for every time, especially in cases of abnormal or unusual morphology of the root canal. The user need coordinate with x-ray to check the results of the measurement.

If the meter does not move when you enter the file, it is possible that the unit is not working normally, therefore, stop using.

### 7.3 Apex operation and not suitable condition

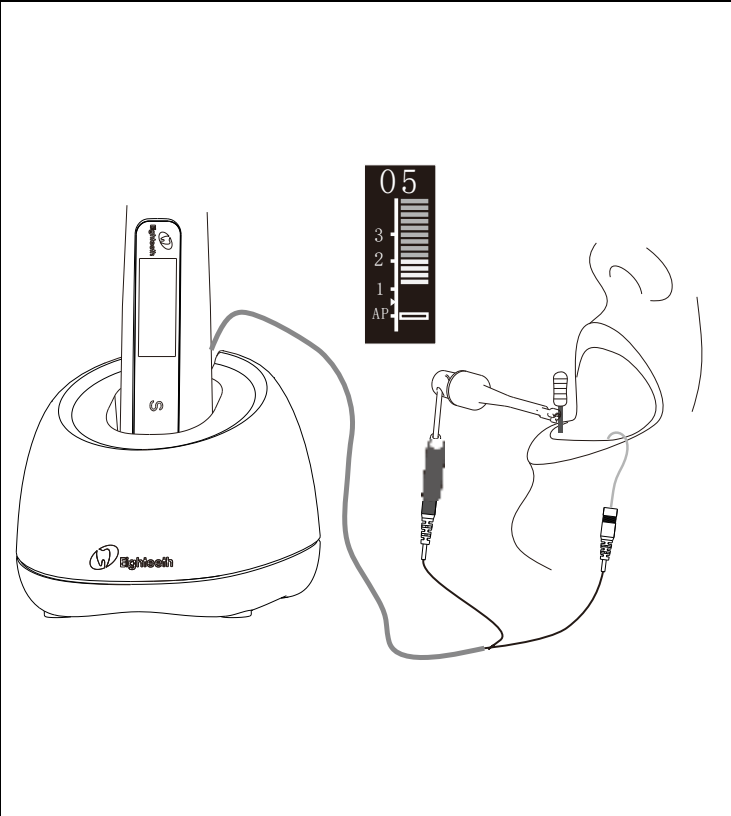

When using as a stand-alone apex locator. We suggest put the handpiece on the charge base to get better visual angle.

the measure wire must be connecting with motor by USB socket, white slot connects with lip by lip hook, and black slot connect with file clip.

the canal length indicator bar will show on the screen **(more information about canal length indicator bar, please see chapter 5.2 Screen display).**

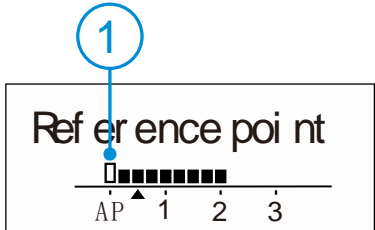
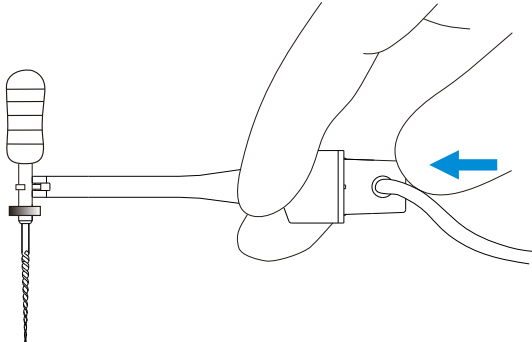
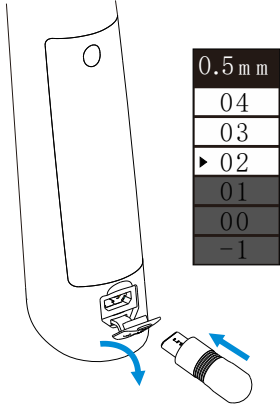
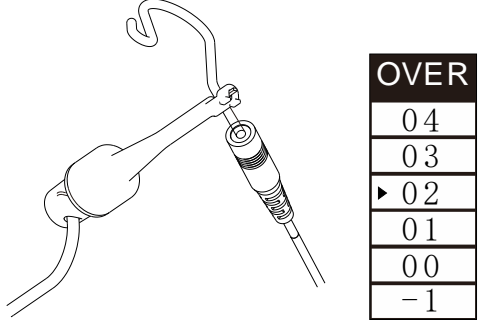
	<p>The reference point can be adjusting when use stand-alone apex function. Press <b>S</b> to active reference point interface during M0 standby state, Press <b>&lt;</b> or <b>&gt;</b> to change reference point by change the flash bar ( <b>○,1</b> ), a continuous beeping with appear when reach the reference point.</p>
	<p><b>NOTE</b></p> <p>The file clip must hold the file correctly. Push the button of file clip in the direction shown by the arrow, clip the holder onto the metal upper part of the file and then release the button.</p> <p>The file clip must be nearly vertical with file handle, otherwise will damage the tip of the file holder.</p>
	<p><b>NOTE</b></p> <p>We recommend using Apex Tester to check the accuracy of apex locator every time before use.</p> <p>Insert the Apex Tester into handpiece USB socket during M0 mode, check the highlight number must between 01-03 (0.3mm-0.8mm on the top)</p>
	<p><b>NOTE</b></p> <p>We recommend check the connection of apex locator every time before use.</p> <p>Touch the lip hook with metal part of file clip, check all the bars on the meter on the screen light up, and “over” flash on</p>



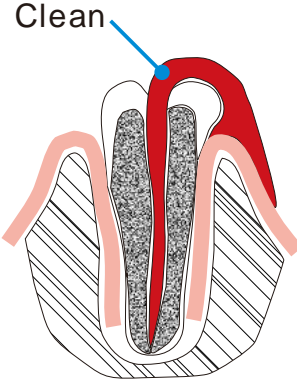

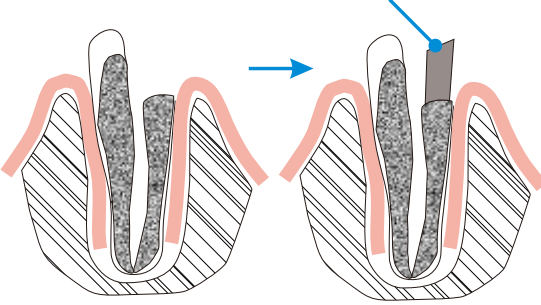
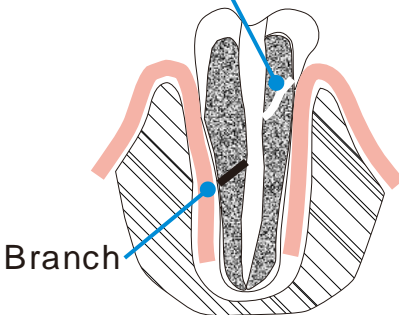
	<p>the top.</p>
<p><b>Unsuitable situation of root canals for Electric Measurement</b></p> <p>Cannot obtain precise measurements if the root canal conditions as below</p>	
	<p><b>Root canal with a large apical foramen</b></p> <p>The root canal cannot be accurately measured because of the lesion or incomplete development of the apical foramen. The results may show that the length measured is shorter than the actual one.</p>
	<p><b>Root canal blood overflow from the opening</b></p> <p>If blood spills from the root opening and contacts the gums, it will cause leakage of electricity, which cannot be accurately measured. Wait for the bleeding to stop completely. Clean the root canal and the opening, completely empty the root canal blood, and then measure it.</p> <p><b>The root canal uses a chemical solution to flow out from the opening</b></p> <p>If a chemical solution flows out of the root canal, it is impossible to get an accurate measurement.</p> <p>It is important to remove the overflow</p>

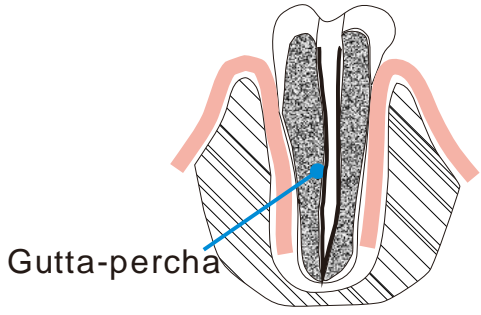
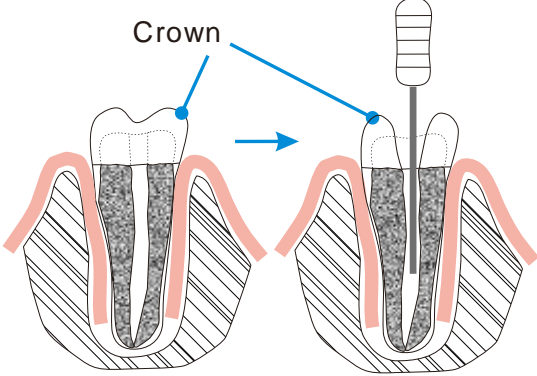
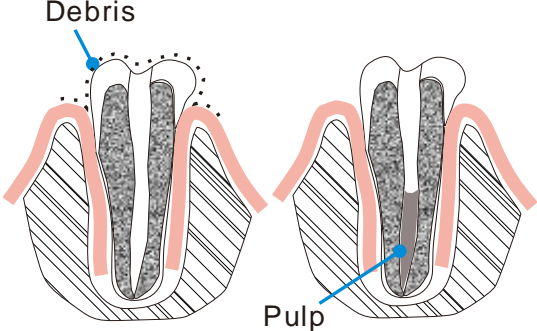
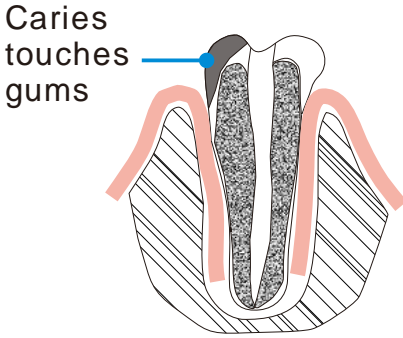
	<p>from the opening.</p>
<p>Build-up (e.g. cement)</p> 	<p><b>Broken crown</b></p> <p>If the crown is broken, a segment of the gingival tissue enters the lumen, and the contact between the gingival tissue and the root file causes electrical leakage, which cannot be accurately measured. In this case, the appropriate material should be used to isolate the gingival tissue.</p>
<p>Crack</p> <p>Branch</p> 	<p><b>The crack tooth Leakage through branch of the root canal</b></p> <p>Broken teeth can cause electrical leakage and cannot be accurately measured.</p> <p>Branch tubes can also cause leakage.</p>

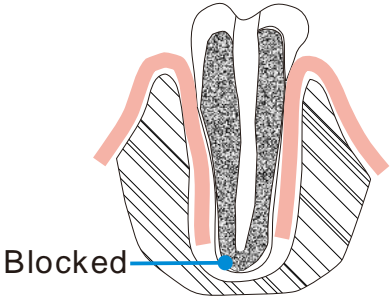
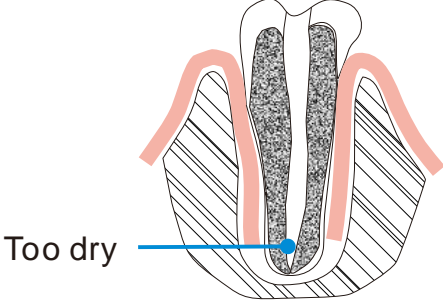
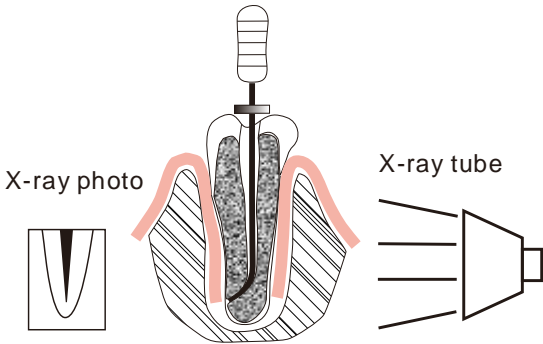
 <p>Gutta-percha</p>	<p><b>Retreatment canal which was filled with gutta-percha</b></p> <p>The gutta-percha must be completely removed to eliminate its insulation, then pass a small file all the way through the apical foramen and then put a little saline in the canal, but do not let it overflow the canal opening.</p>
 <p>Crown</p>	<p><b>Crown or metal prosthesis that touches gingival tissue</b></p> <p>Accurate measurement cannot be obtained if the file touches a metal prosthesis that is touching gingival tissue. In this case, widen the opening at the top of the crown so that the file will not touch the metal prosthesis before taking a measurement.</p>
 <p>Debris</p> <p>Pulp</p>	<p><b>Cutting debris on tooth Pulp inside canal</b></p> <p>Remove all cutting debris on the tooth.</p> <p>Remove all the pulp inside the canal. Otherwise an accurate measurement cannot be obtained.</p>
 <p>Caries touches gums</p>	<p><b>Caries touching the gums</b></p> <p>In this case, electrical leakage through the caries infected area to the gums are impossible to obtain an accurate measurement.</p>

	<p><b>Blocked canal</b></p> <p>The meter will not run if the canal is blocked. Opening the canal all the way to the apical construction to measure it.</p>
	<p><b>Extremely dry canal</b></p> <p>If the canal is extremely dry, the meter may not work until it is quite close to the apex. In this case, try to moisten the canal with oxydol or saline.</p>
<p><b>Difference measuring result between Apex locator reading and Radiography</b></p> <p>Sometimes the reading of the apex locator reading does not correspond to the X-ray image. this does not mean inaccurate of apex locator or X-ray, depending on the angle of the X-ray beam, the root tip may not be displayed correctly. The position of the root tip seems to differ from its true position.</p>	
	<p>The X-ray photo shows that the actual apex of the root canal is not the same as the anatomic end. In fact, the apical foramen is located at the coronal end. in this case, X-ray may indicate that the file needle has not reached the apical foramen, even if it has actually reached the apical foramen.</p>

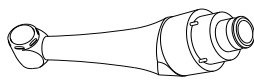
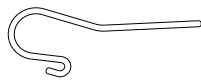
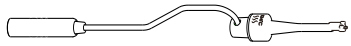
## 8.Maintenance

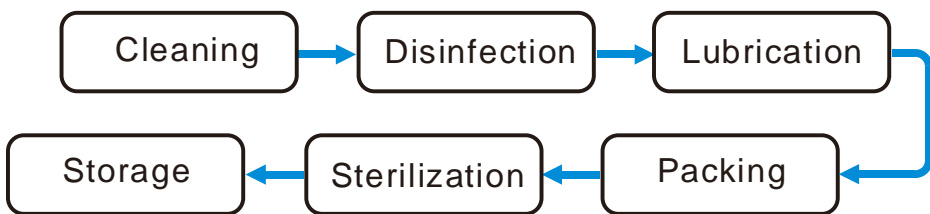
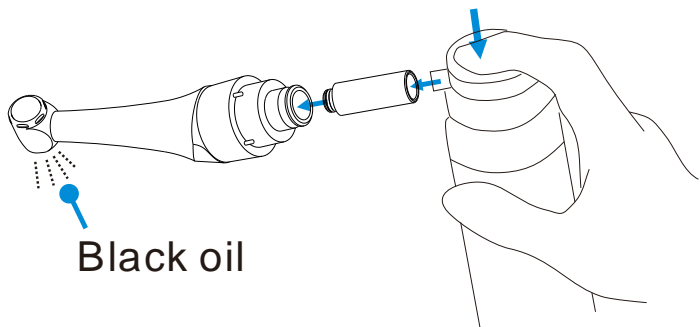
Autoclavable Components			
Contra Angle 	Lip Hook 	File clip 	Insulating Sleeve 
 <b>WARNING</b> Only the components above can be autoclaved.			
Autoclavable Procedure			
			
<b>Cleaning:</b> Clean the components with running water with a soft cloth.			
<b>Disinfection:</b> Wipe the components with a piece of gauze that has been dampened with Ethanol for Disinfection (Ethanol 70 to 80 vol%) and wrung out thoroughly.			
<b>Lubrication:</b> Only the contra angle needs to be lubricated		Before autoclaving, the contra angle must be lubricated.	
 <p>Black oil</p>		Attaching the spray nozzle to oil can and contra angle, press the oil can button more than 3 seconds, till all the black oil flow out from the head of the contra angle.	
<b>Packing:</b> Pack the components in “Sterilization pouches”.			
<b>Sterilization:</b> Steam sterilization at 134°C at least 4 minutes or steam sterilization at 121°C at least 35 minutes.			

Minimum drying time after sterilization: 10 minutes.

**Storage:** Keep the components in sterilization packaging in a dry and clean environment.



**WARNING**





Comply with your national guidelines, standards and requirements for cleaning, disinfection and sterilization.

Be careful to avoid cross contamination when performing maintenance.

Must be autoclaved after use for each.

Do not lubricate the motor handpiece.

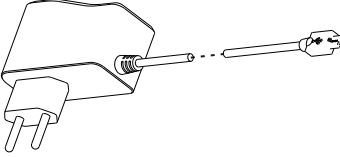
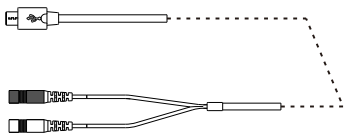
### Disinfection components

<p>Motor Handpiece</p> 	<p>Charge Base</p> 	<p>Adapter</p> 
<p>Measuring Wire</p> 	<p>Handpiece Base</p> 	

Wipe the components with a piece of gauze that has been dampened with Ethanol for Disinfection (Ethanol 70 to 80 vol%) and wrung out thoroughly.



**NOTE**

Do not use anything except Ethanol for Disinfection (Ethanol 70 to 80 vol%).  
 Do not use too much ethanol as it's going into machine and damage the components inside.

### Single-use component

<p>Disposable Sleeve</p> 		
--	--	--



**NOTE**

Single-use handle sleeve must be disposed of and changed after every treatment. In the event of non-compliance, the contamination risk increases.

## 9.Error Warning

<div style="border: 1px solid black; padding: 5px; text-align: center;"> <p><b>Overload</b> Restart Motor</p> </div>	<p>When setting the torque limit as R.L or during reverse processing, the Overload warning may appear on the screen, it means a large load happened greater than the motor force.</p> <p>Press the Main switch to restart motor.</p>
<div style="border: 1px solid black; padding: 5px; text-align: center;"> <p><b>Overheat</b> See user manual</p> </div>	<p>The temperature of motor is higher than expectation, turn the power off and waiting more than 5 minutes to let it cold down.</p>
<div style="border: 1px solid black; padding: 5px; text-align: center;"> <p><b>HWFault</b> See user manual</p> </div>	<p>Hardware of the handpiece broken, contact your distributor.</p>
<div style="border: 1px solid black; padding: 5px; text-align: center;"> <p><b>MotorFault</b> See user manual</p> </div>	<p>Motor of the handpiece broken, contact your distributor.</p>
<div style="border: 1px solid black; padding: 5px; text-align: center;"> <p><b>LowPower</b> Please Charge</p> </div>	<p>The power is very low, charge it immediately</p>



## 10.Troubleshooting

When trouble is found, check the following points before contacting your distributor. If none of these are applicable or the trouble is not remedied even after action has been taken, the product may have failed. Contact your distributor.

Problem	Cause	Solution	Ref. chap
The power is not turned on.	The battery is flat.	Charge the battery.	7.1
	Press the main switch too short time.	Press the main switch more than 0.5 seconds.	5.1
The power LED on charge base does not light.	Using a wrong adapter.	Use the original adapter.	4.4
	The adapter is not connected.	Check the connection.	4.4
	The plug of the adapter is not inserted into the outlet.	Check the connection.	/
	There is no electricity in the outlet.	Check the connection.	/
No charge indicator flash on handpiece screen	Put the handpiece into the charge base in the wrong direction.	Check the direction.	4.4
	Charge pin of charge base unable to rebound.	Remove debris which between move part and base of the charge pin.	/
	Contactors are dirty.	Cleaning the surface of contactors.	/
	The charge base broken.	using adapter connect to handpiece directly, and Contact your distributor.	/
Handpiece	The handpiece broken.	Check if there is a sound of beep or motor, and	/

screen does not appear		Contact your distributor.	
The motor doesn't rotate.	M0 mode is stand-alone apex locator function.	Changing to M1-M10.	6.1
	The contra-angle is clogged	Clean or replace the contra-angle.	/
	Motor is protected by system or broken.	Check the error warning.	9
Motor does not run when the file is inserted in the canal.	The measure wire connecting not properly.	Check the connection.	4.3
	The lip hook not properly hooked in the corner of the patient's mouth.	Check the connection.	7.2 7.3
	The Auto start function is OFF	Turn the auto start function ON if necessary.	6.2
The motor Can't stop.	The Auto stop function is OFF.	Press main switch to stop it, setting Auto stop function ON if necessary.	6.2
	There is a short circuit inside the motor handpiece or the motor handpiece cord.	Press "S" button to stop the motor and contact your distributor.	/
Motor spontaneously starts running in reverse.	Up to setting torque limit.	Check the torque limit is enough or not.	6.2
	Apical action setting to Reverse	Change setting if it's not expected.	6.2
	Setting to REV mode.	Change setting if it's not expected.	6.2
Motor does not reverse.	R.L mode is set.	Change setting if it's not expected.	6.2
	Torque reverse setting might be too high.	Change setting if it's not expected.	6.2

	Apical action setting Stop or OFF.	Change setting if it's not expected.	6.2
Motor speed changes spontaneously.	Apical action setting Slow Down.	Change setting if it's not expected.	6.2
Motor alternates between forward and reverse rotation.	Operation mode setting to REC or ATC.	Change setting if it's not expected.	6.2
No sound.	Beep volume set to 0.	Set beep volume to 1, 2 or 3.	6.4
Beep sound an alarm even though the instrument is not being used.	The motor is set to REV or R.L mode.	If it is the expected mode, ignore the alarm.	6.2
Canal measurement is unstable.	Complex root canal environment.	Check situation of root canals.	7.3
Cannot make a measurement.	Measure wire, lip hook or file clip connecting not properly.	Check the connection.	7.2 7.3
	Lack electrical conductivity between the shank and the file.	Use a file that has conductivity.	/
	Unsuitable situation of root canals.	Check the root canal environment.	7.3

## 11. Technical Data

Manufacturer	Changzhou eighteenth medical technology Co.,Ltd
Model	E-connect S
Dimensions	21.5cm x 17.5cm x 9cm (Outer box)
Weight	800g
Contra-angle	Contra-angle compatible with rotary and reciprocating instruments, equipped with a 2.35 mm shaft conforming to ISO 1797-1:2011, Type 1
Power supply	Lithium ion battery: 3.7V, 1500mAh
Charger power supply	AC 100-240 V
Frequency	50/60Hz
Charger nominal power input	5.5VA
Torque range	0.5Ncm – 4Ncm
Speed range	120-1000 rpm
Electrical safety class	Class II
Applied part	BF
Ambient conditions	Use: in enclosed spaces Ambient temperature: 15°C / 35 °C Relative humidity: <80%; non-condensing at 0° Operating altitude < 2000 m above sea level
Transport and storage conditions	Ambient temperature: -20 °C / +50 °C Relative humidity: 20% - 80 %, non-condensing at > 40 °C Atmospheric pressure: 50 kPa - 106 kPa

## 12.EMC Tables

<b>Guidance and manufacturer's declaration – electromagnetic emissions</b>		
<p>The <b>E-connect S</b> is intended for use in the electromagnetic environment specified below. The customer or the user of the <b>E-connect S</b> should assure that it is used in such an environment.</p>		
<b>Emissions test</b>	<b>Compliance</b>	<b>Electromagnetic environment - guidance</b>
RF emissions CISPR 11	Group 1	The <b>E-connect S</b> uses RF energy only for its internal function. Therefore, its RF emissions are very low and are not likely to cause any interference in nearby electronic equipment.
RF emissions CISPR 11	Class B	The <b>E-connect S</b> is suitable for use in all establishments, including domestic establishments and those directly connected to the public low-voltage power supply network that supplies buildings used for domestic purposes.
Harmonic emissions IEC61000-3-2	Not applicable	
Voltage fluctuations/flicker emissions IEC 61000-3-3	Not applicable	

<b>Guidance and manufacturer's declaration – electromagnetic immunity</b>			
<p>The <b>E-connect S</b> is intended for use in the electromagnetic environment specified below. The customer or the user of the <b>E-connect S</b> should assure that it is used in such an environment.</p>			
<b>Immunity test</b>	<b>IEC 60601 test level</b>	<b>Compliance level</b>	<b>Electromagnetic environment - guidance</b>

Electrostatic discharge (ESD) IEC 61000-4-2	$\pm 6$ kV contact  $\pm 8$ kV air	$\pm 2, 4, 6$ kV contact  $\pm 2, 4, 8$ kV air	Floors should be wood, concrete or ceramic tile. If floors are covered with synthetic material, the relative humidity should be at least 30 %.
Electrical fast transients/bursts IEC 61000-4-4	$\pm 2$ kV for power supply lines  $\pm 1$ kV for input/output lines	Not applicable  Not applicable	The test is applicable since the EUT does not have AC/DC power ports and signal/interconnecting cable longer than 3m.
Surge IEC 61000-4-5	$\pm 1$ kV line(s) to line(s)  $\pm 2$ kV line(s) to earth	Not applicable  Not applicable	The test is not applicable since the EUT does not have AC power port.
Voltage dips, short interruptions and voltage variations on power supply lines IEC 61000-4-11	$< 5\% U_T$ ( $> 95\%$ dip in $U_T$ ) for 0.5 cycle  $40\% U_T$ ( $60\%$ dip in $U_T$ ) for 5 cycles  $70\% U_T$ ( $30\%$ dip in $U_T$ ) for 25 cycles  $< 5\% U_T$ ( $> 95\%$ dip in $U_T$ ) for 5 sec	Not applicable  Not applicable  Not applicable	The test is not applicable since the EUT does not have AC power port.

Power frequency (50/60 Hz) magnetic field IEC 61000-4-8	3 A/m	3 A/m	Power frequency magnetic field should be at levels characteristic of a typical location in a typical commercial or hospital environment.
Note $U_T$ is the a.c. mains voltage prior to application of the test level.			

<b>Guidance and manufacturer's declaration – electromagnetic immunity</b>			
The <b>E-connect S</b> is intended for use in the electromagnetic environment specified below. The customer or the user of the <b>E-connect S</b> should assure that it is used in such an environment.			
<b>Immunity test</b>	<b>IEC 60601 test level</b>	<b>Compliance level</b>	<b>Electromagnetic environment - guidance</b>
Conducted RF  IEC 61000-4-6  Radiated RF	3 Vrms  150 kHz to 80 MHz	3 V  V/m	Portable and mobile RF communications equipment should be used no closer to any part of the <b>E-connect S</b> , including cables, than the recommended separation distance calculated from the equation applicable to the frequency of the transmitter.  <b>Recommended separation distance</b>  $d = 1.2\sqrt{P}$  $d = 1.2\sqrt{P}$ 80 MHz ~ 800 MHz  $d = 2.3\sqrt{P}$ 800 MHz ~ 2.5 GHz

IEC 61000-4- 3	3 V/m  80 MHz to 2.5 GHz	3.5 V/m	<p>Where <math>P</math> is the maximum output power rating of the transmitter in watts (W) according to the transmitter manufacturer and <math>d</math> is the recommended separation distance in meters (m). Field strengths from fixed RF transmitters, as determined by an electromagnetic site survey, <sup>a</sup>should be less than the compliance level in each frequency range. <sup>b</sup></p> <p>Interference may occur in the vicinity of equipment marked with the following symbol:</p> 
----------------------	-----------------------------------	------------	--

NOTE 1: At 80 MHz and 800 MHz, the higher frequency range applies.

NOTE 2: These guidelines may not apply in all situations. Electromagnetic propagation is affected by absorption and reflection from structures, objects and people.

<sup>a</sup> Field strengths from fixed transmitters, such as base stations for radio (cellular/cordless) telephones and land mobile radios, amateur radio, AM and FM radio broadcast and TV broadcast cannot be predicted theoretically with accuracy. To assess the electromagnetic environment due to fixed RF transmitters, an electromagnetic site survey should be considered. If the measured field strength in the location in which the **E-connect S** is used exceeds the applicable RF compliance level above, the **E-connect S** should be observed to verify normal operation. If abnormal performance is observed, additional measures may be necessary, such as reorienting or relocating the **E-connect S**.

<sup>b</sup> Over the frequency range 150 kHz to 80MHz, field strengths should be less than 3 V/m.

### Recommended separation distances between portable and mobile RF communications equipment and the E-connect S.

The **E-connect S** is intended for use in an electromagnetic environment in which radiated RF disturbances are controlled. The customer or the user of the **E-connect S** can help prevent electromagnetic interference by maintaining a minimum distance between portable and mobile RF communications equipment (transmitters) and the **E-connect S** as recommended below, according to the maximum output power of the communications equipment.



<b>Rated maximum output power of transmitter</b> W	<b>Separation distance according to frequency of transmitter</b> m		
	<b>150 kHz to 80 MHz</b> $d = 1.2\sqrt{P}$	<b>80 MHz to 800 MHz</b> $d = 1.2\sqrt{P}$	<b>800 MHz to 2.5 GHz</b> $d = 2.3\sqrt{P}$
0.01	0.12	0.12	0.23
0.1	0.38	0.38	0.73
1	1.2	1.2	2.3
10	3.8	3.8	7.3
100	12	12	23

For transmitters rated at a maximum output power not listed above, the recommended separation distance  $d$  in meters (m) can be estimated using the equation applicable to the frequency of the transmitter, where  $P$  is the maximum output power rating of the transmitter in watts (W) according to the transmitter manufacturer.

NOTE 1: At 80 MHz and 800 MHz, the separation distance for the higher frequency range applies.

NOTE 2: These guidelines may not apply in all situations. Electromagnetic propagation is affected by absorption and reflection from structures, objects and people.

## 13.Statement

All rights of modifying the product are reserved to the manufacturer without further notice. The pictures are only for reference. The final interpretation rights belong to CHANGZHOU EIGHTEETH MEDICAL TECHNOLOGY CO., LTD. The industrial design, inner structure, etc, have claimed for several patents by EIGHTEETH, any copy or fake product must take legal responsibilities.



## **Changzhou Eighteeth Medcial Technology Co., Ltd**

Add: NO.99 Qingyang Road Xuejia Town, Xinbei District Changzhou City, 213125,  
Jiangsu Province, China

Tel: +86-0519-85962691

Fax: +86-0519-85962691

Email: ivy@sifary.com

Web: www.eighteeth.com

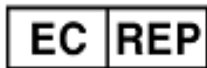

Berwin Indusdy Ltd.

Tel: +44 0208 492 6388

Fax: +44 0208 492 0196

Add: 419, Harborne Road, Edgbaston, Birmingham, B15 3LB.

William Jefferson

Christophe.strole@yahoo.com

Version: A0

BKY-CE-60-1007

Issued: Mar. 26, 2018

Copyright © Eighteeth Ltd, 2016.

All rights reserved.